

V15 V20 V30 Roof Integrated Solar Heating Panels



- Clean, low-profile aesthetic
- Range of sizes can be joined or spaced apart on the roof
- Compatible with the widest range of roof coverings
- Enables clarity of responsibility and safe working practices
- Fits in with the build programme
- Combines seamlessly with Clearline PV solar panels

Mechanical Specification

Model		V15	V20	V30
Width (across roof)	mm	1,167	1,167	1,167
Height (up roof)	mm	1,482	2,046	2,892
Thickness	mm	82	82	82
Weight (empty)	kg	31.0	43.5	62.0
Static roof loading (distributed)	kg / m ²	17.9	18.2	18.4
Rated Flow	litres/hour	75	105	150
Pressure Drop at Rated Flow	kPa	7.0	12.1	34.2
Fluid Volume	litres	0.75	1.0	1.5
Max. Hydraulic Pressure	bar	3.0		
Wind Exposure Limit	Pa	4,100		
Fire Rating to BS 476-3		AA		
Warranty	years	10		
Standards		EN 12975, BBA, MCS		

Clearline solar panels have been thoroughly tested, not only as energy generating equipment, but also as a building component and were the first solar panel to achieve a BBA certificate.

Performance Specification

Model		V15	V20	V30
Absorber Area	m ²	1.49	2.10	3.0
Zero Loss Efficiency	η_0	0.81		
Heat Loss Coefficient	a_1	W/m ² K		
Second Order	a_2	W/m ² K ²		
I.A.M. (50°)	K_b	0.94		
Effective Heat Capacity	C_{eff}	kJ/m ² K		
		6.0		

Efficiency Curve

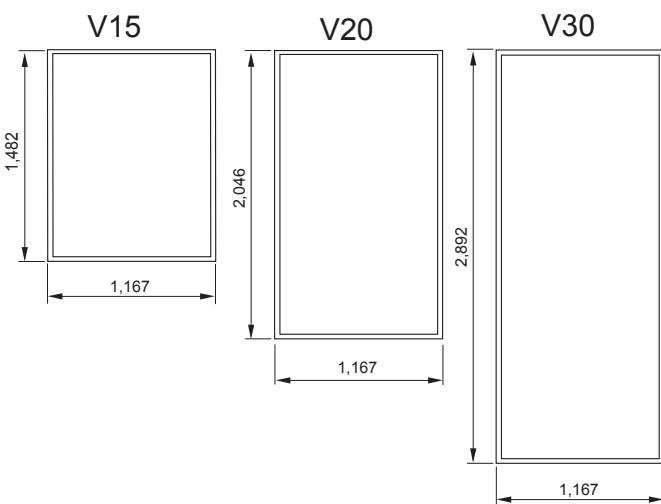
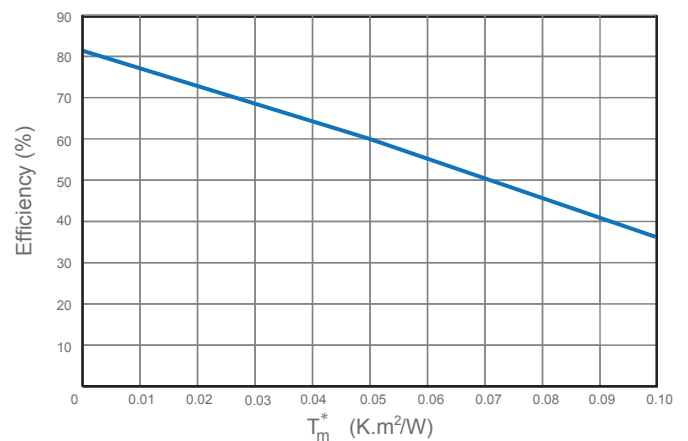

Also available



Clearline PV
Photovoltaic solar panels



Symphony Cylinder
Solar-optimised hot water store



Clearline Aura
Wireless solar energy display



Pitched Roof Integration

Clearline solar panels are only 82mm thin and fit over tile battens with no modification to the roof structure. When integrated with rolling tiles, the panels finish flush with the tile surface. Connections are neatly tucked away behind and hidden from sight. The choice of three panel sizes, together with options to install either joined together or spaced apart on the roof, gives a wide range of options to integrate renewable energy and remain in harmony with the building design.



T Series Tiled Roof

Interlocking and plain tiles
thickness > 19mm
Pitch 20-60°

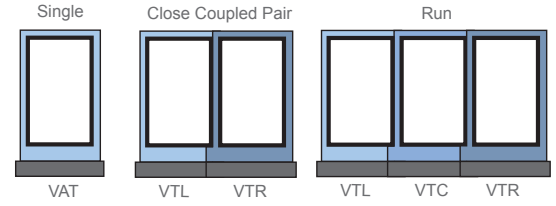

S Series Slate Roof

Natural and artificial slates
thickness < 10mm
Pitch 20-60°

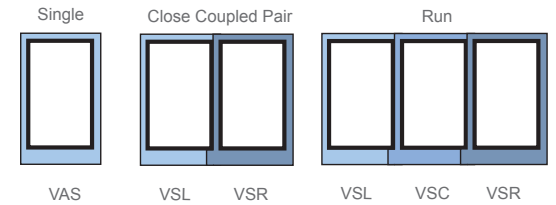

T Series Flashings

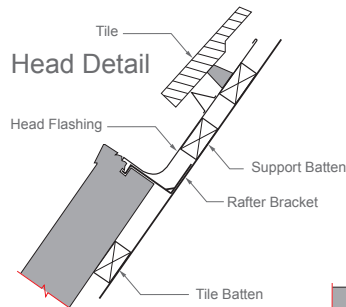
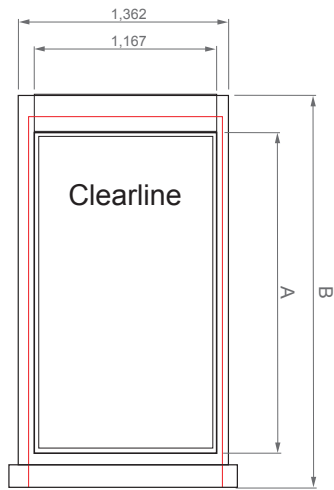

	V15	V20	V30
A	mm 1,482	2,046	2,892
B	mm 1,980	2,543	3,389

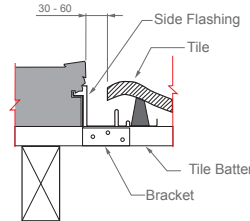

Side Detail

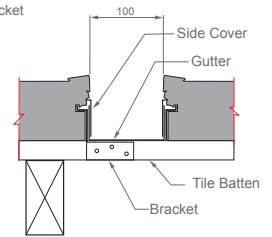
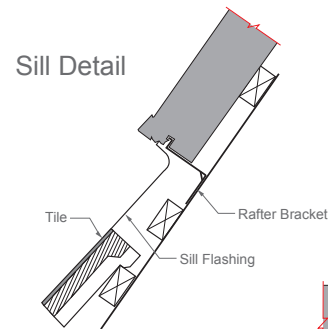

Gutter Detail
(joined flashings)

S Series Flashings

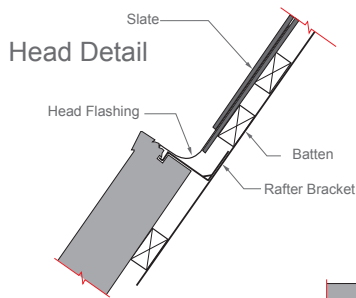
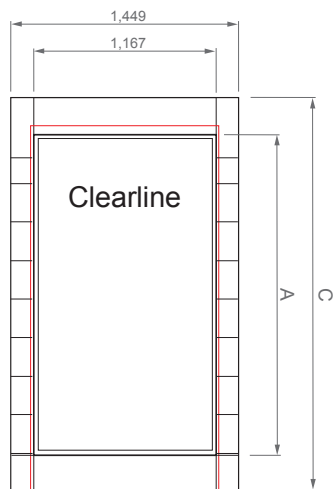

	V15	V20	V30
A	mm 1,482	2,046	2,892
C	mm 1,946	2,509	3,355

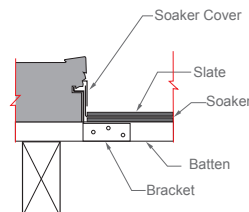

Side Detail

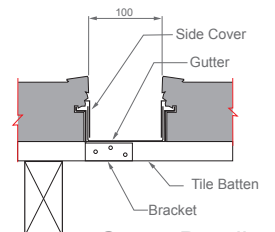
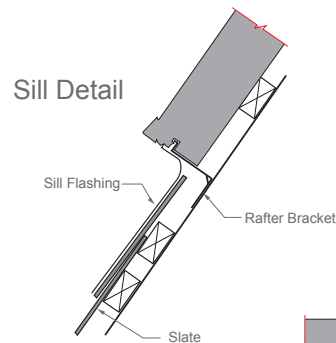

Gutter Detail
(joined flashings)