

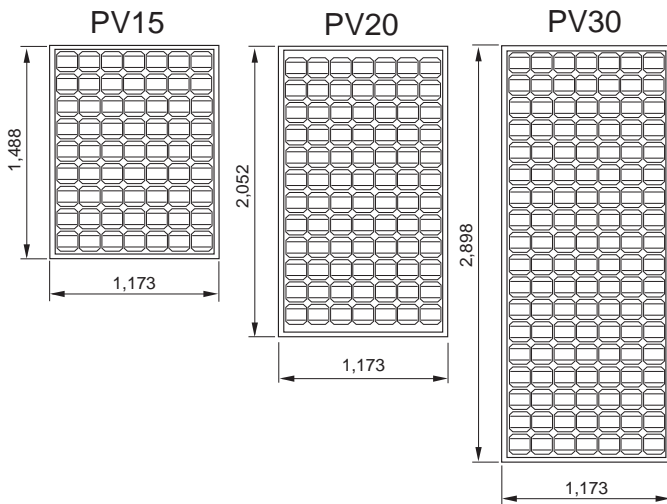

- Simple roof integration with clean, low-profile aesthetic
- Range of sizes can be joined or spaced apart on the roof
- Compatible with the widest range of roof coverings
- Fitted during the normal roofing programme, enabling clarity of responsibility and safe working practices
- Properly tested as a building material
- Combines seamlessly with Clearline heating panels



Also available



Flat Roof Mounting
for rapid installation



Clearline
Solar heating panels



Symphony Cylinder
Optimised for solar

Mechanical Specification

Model		PV15	PV20	PV30
Aperture Area	m ²	1.5	2.1	3.0
Width (across roof)	mm	1,173	1,173	1,173
Height (up roof)	mm	1,488	2,052	2,898
Thickness	mm	82	82	82
Weight	kg	30.0	41.0	57.0
Static roof loading (distributed)	kg / m ²	17.2	17.0	16.8
Characteristic Wind Resistance	kPa	3.4		
Ultimate Design Load ¹	kPa	2.4		
Fire Rating to BS 476-3		AA		
Power Warranty	% rated	90% 10 years, 80% 25 years		
Standards		IEC61215, 61730, TUV, MCS, BBA		

Clearline PV solar panels have been thoroughly tested, not only as energy generating equipment, but also as a building component and were the first solar pv panel to achieve a BBA certificate.

Electrical Specification

Model		PV15	PV20	PV30
Peak Power ²	Wp	240	320	485
Module Efficiency ³	%	16.0	15.2	16.2
Number of Cells		63	84	126
Maximum Power Voltage (V _{mpp})	V	31.9	42.5	63.3
Maximum Power Current (I _{mpp})	A	7.5	7.5	7.7
Open Circuit Voltage (V _{oc})	V	39.4	52.6	78.9
Short Circuit Current (I _{sc})	A	8.3	8.3	8.2
NOCT ⁴	°C	44.6	44.6	44.6
Cell Type		Monocrystalline Silicon		
Maximum System Voltage	V _{oc}	1,000		
Power Temperature Coefficient	% / °C	-0.509		
Current Temperature Coefficient	% / °C	0.043		
Voltage Temperature Coefficient	% / °C	-0.337		
Safety Classification		Class II		

I-V Curves

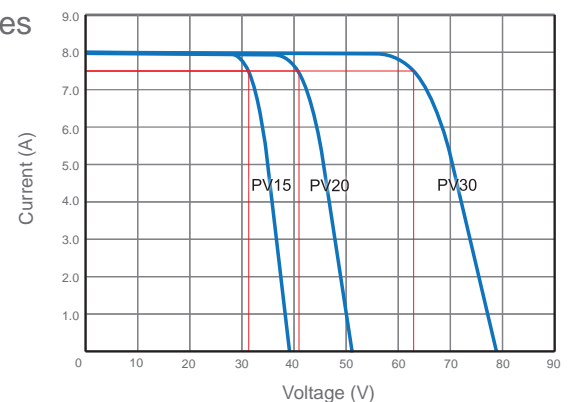

¹ Design resistance to ultimate loads includes a partial material safety factor of 1.44

² Subject to a manufacturing tolerance of +/- 5%.

³ Based on aperture area.

⁴ Nominal Operating Cell Temperature

Electrical specification measured under standard test conditions: Irradiation 1 kW/m² with light spectrum AM 1.5 and a cell temperature of 25°C.

Pitched Roof Integration

Clearline solar panels are only 82mm thin and fit over tile battens with no modification to the roof structure. When integrated with rolling tiles, the panels finish flush with the tile surface. Connections are neatly tucked away behind and hidden from sight. The choice of three panel sizes, together with options to install either joined together or spaced apart on the roof, gives a wide range of options to integrate renewable energy and remain in harmony with the building design.



T Series Tiled Roof

Interlocking and plain tiles
thickness > 19mm
Pitch 20-60°

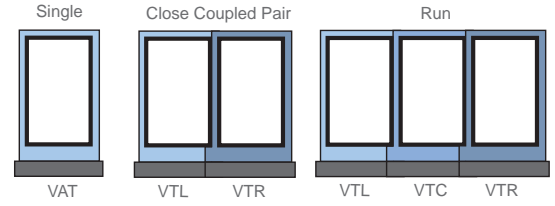

S Series Slate Roof

Natural and artificial slates
thickness < 10mm
Pitch 20-60°

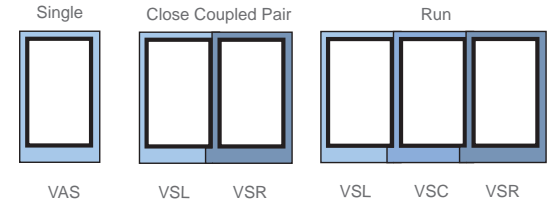

T Series Flashings

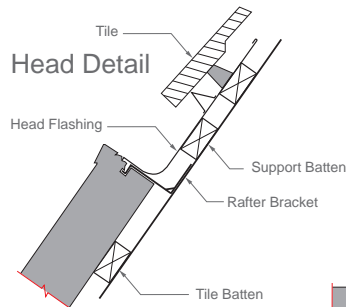
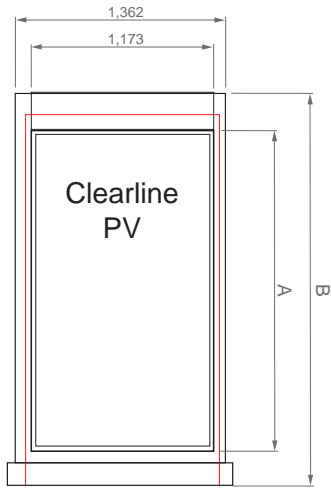

		PV15	PV20	PV30
A	mm	1,488	2,052	2,898
B	mm	1,980	2,543	3,389

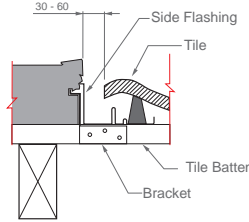

Side Detail

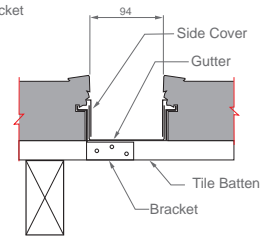
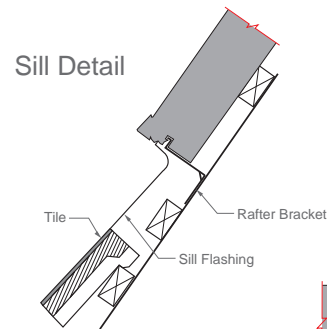

Gutter Detail
(joined flashings)

S Series Flashings

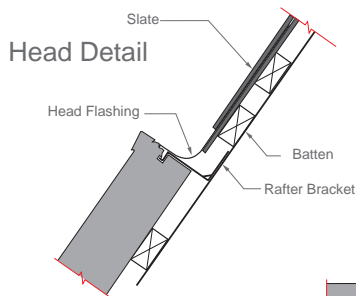
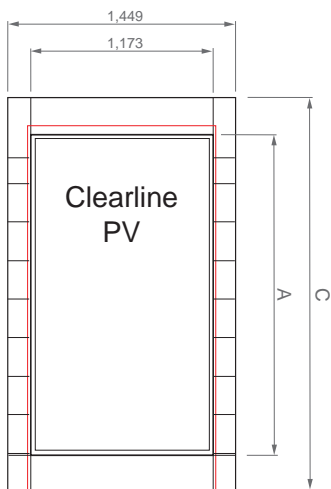

		PV15	PV20	PV30
A	mm	1,488	2,052	2,898
C	mm	1,946	2,509	3,356

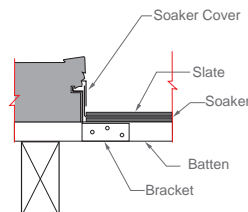

Side Detail

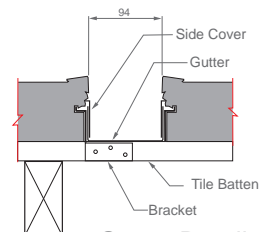
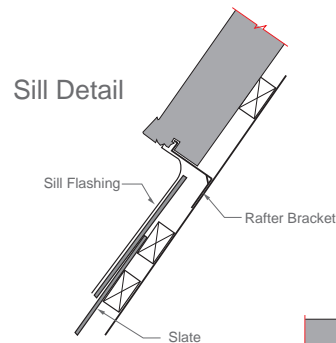

Gutter Detail
(joined flashings)